

Shoulder Houlder II

Warnings and Instructions: Review carefully, proper application is required

⚠ Warning: This device will not prevent or eliminate risk of injury. Do Not Overtighten. If swelling, pain, skin irritation, or an unusual reaction occurs, discontinue use immediately and consult your medical professional.

Care: Hand wash using mild soap. Rinse thoroughly. Air dry only. Do not tumble dry.

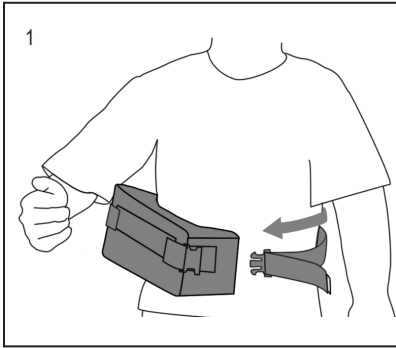

1. Place pillow against body and secure waist strap around waist.

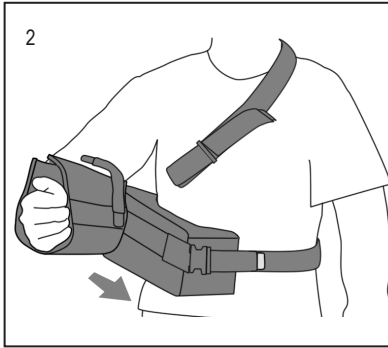

2. Place affected elbow in corner of elbow pocket. Attach brace to pillow.

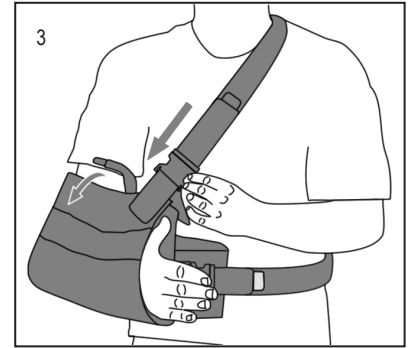

3. Fasten ends of shoulder strap to front corners of brace. Secure arm in brace with elbow strap

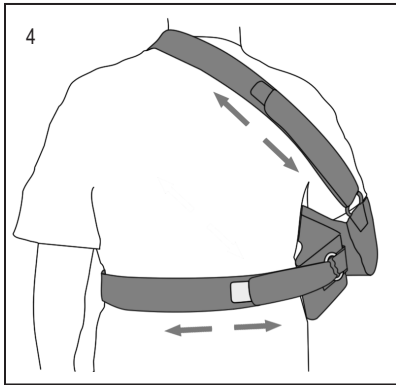

4. Have practitioner adjust back straps before first time use.

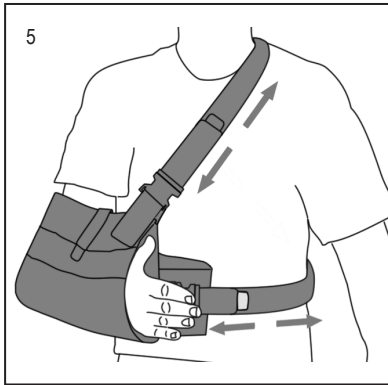

5. Make final adjustments to brace using front straps.

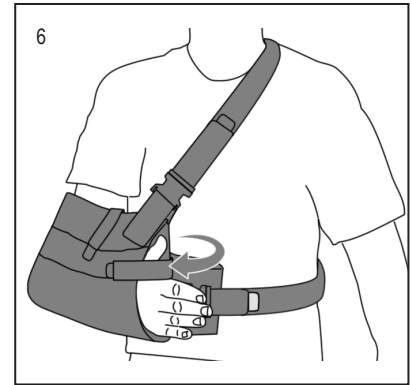

6. Secure thumb strap.

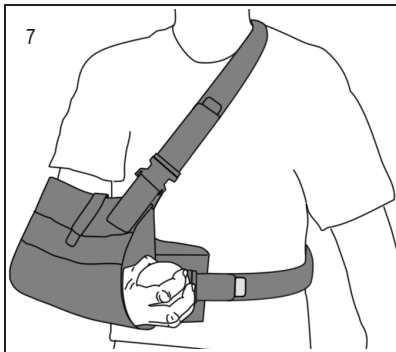

7. Completed application. Remove brace using quick release buckles.

See the remove pillow step down application on back

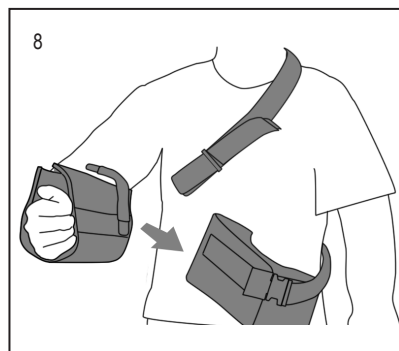

8



Scan to view application video

HELY & WEBER

© 2025 Weber Orthopedics Inc. DBA
Hely & Weber all rights reserved



Shoulder Houlder II Remove Pillow

Warnings and Instructions: Review carefully, proper application is required

⚠ Warning: This device will not prevent or eliminate risk of injury. Do Not Overtighten. If swelling, pain, skin irritation, or an unusual reaction occurs, discontinue use immediately and consult your medical professional.

Care: Hand wash using mild soap. Rinse thoroughly. Air dry only. Do not tumble dry.

REMOVE PILLOW STEP DOWN APPLICATION

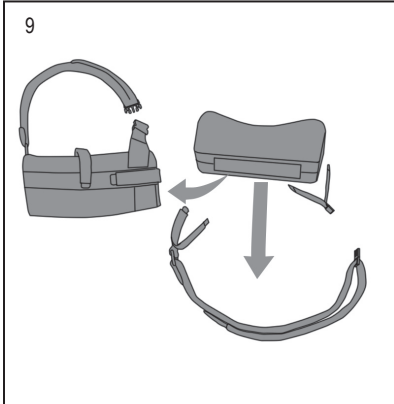

9. Use quick release clips to remove brace from patient. Remove pillow from brace. Detach straps from pillow.

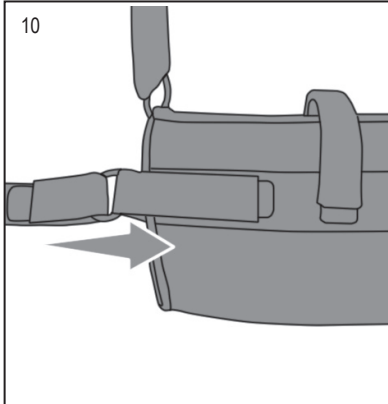

10. Re-attach long end of swath strap to brace at elbow as shown. The strap adjustment fasteners need to be facing out.

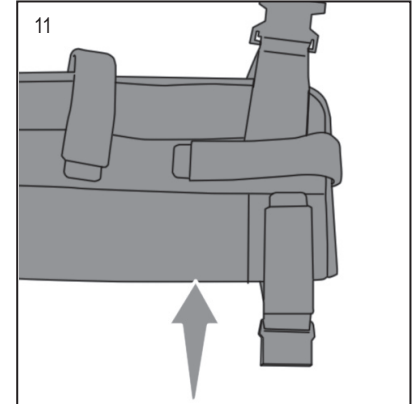

11. Re-attach short piece of swath strap to front of brace as shown.

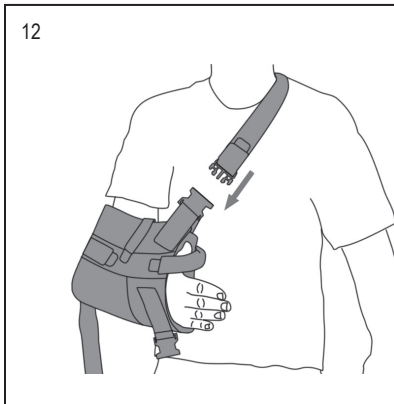

12. Place affected elbow in corner of elbow pocket, and clip in shoulder strap.

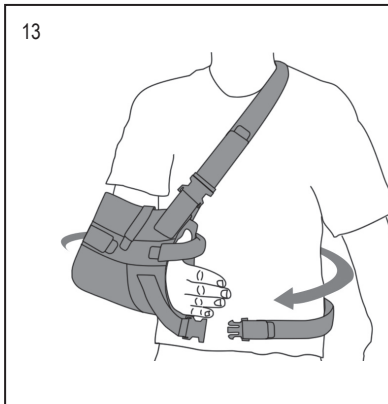

13. Bring swath strap around back, and clip into fastener near front of brace.

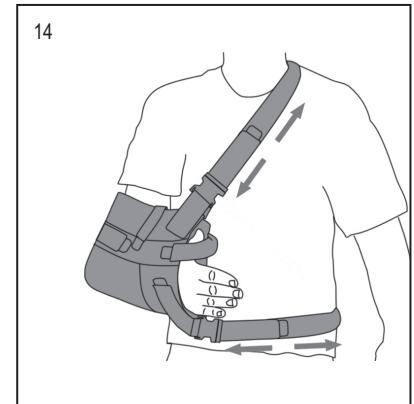

14. Make final adjustments to strap lengths.

HELY & WEBER

© 2025 Weber Orthopedics Inc. DBA
Hely & Weber all rights reserved

